

DATA SHEET MANHOLE SPREAD FOOTER

JOB NO.: _____ JOB NAME: _____ CONTRACTOR: _____

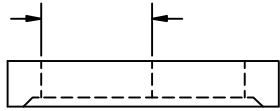

FLAT TOP

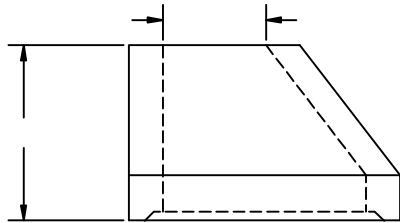

TOP CONE

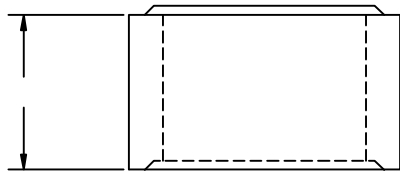

RISER

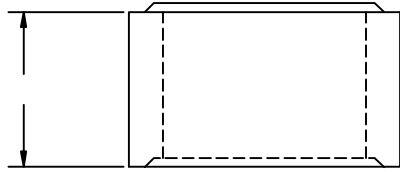

RISER

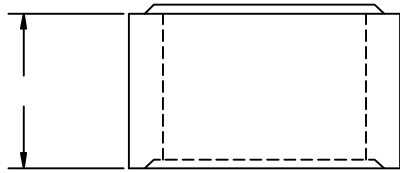

RISER

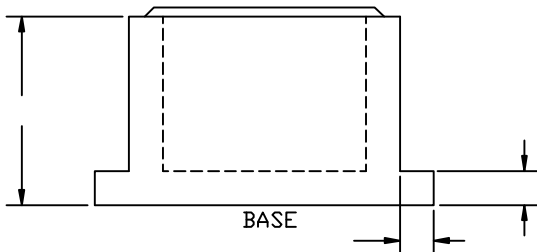

BASE

STEPS	<input type="checkbox"/> ALUM			
	<input type="checkbox"/> C.I.			
	<input type="checkbox"/> PLASTIC			
M.H. TYPE	<input type="checkbox"/> STORM			
	<input type="checkbox"/> SANITARY			
	<input type="checkbox"/> COATED			
MECHANICAL JOINT <input type="checkbox"/>				
HOLES <input type="checkbox"/>				
HOLES	PIPE SIZE	ELEV	ANGLE	ITEM
H1				
H2				
H3				
H4				

TOP ELEVATION _____

TOP INVERT-IN ELEVATION _____

INVERT-OUT ELEVATION _____

BASE ELEVATION _____

CASTING _____

SUMP _____

MANHOLE HEIGHT _____

TOP OF BASE SLAB TO TOP OF CONCRETE

FIELD ADJ. _____

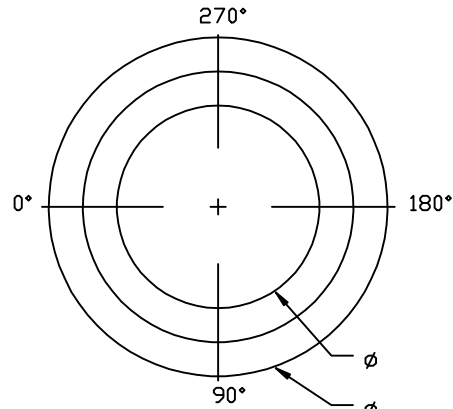

CONCRETE TO TEST TO PSI @ 28 DAYS

540
Ulster landing Road
Kingston, NY 12401

Tel: (845) 336-8880
Fax: (845) 336-8862



PURVEYORS of QUALITY
PRECAST CONCRETE
CUSTOM & STANDARD
FABRICATION

lhvprecast@worldnet.att.net
www.lhvprecast.com